

# FASTUS

\* FASTUS is a product brand of OPTEX FA.

## Easy-to-Read, Easy-to-Use, Ultra-High-Speed Fiber-Optic Sensors

**NEW MODELS**

Short-range/High-accuracy type  
Infrared light source type



Ultra-High-Speed Fiber-Optic Sensors

### D4RF Series

 IO-Link



OPTEX FA CO., LTD.

# Enhanced operability with updated user interfaces

Highly visible OLED display and large LED indicators.

New user-friendly functions, such as hold display of received light amounts.

In addition to these features, IO-Link compatibility allows this new generation Fiber-Optic Sensors to meet the needs of smart factories.

## Fiber insertion indicators to check insertion depth of Fiber-Optic Cables

You can tell at a glance whether fiber wires are inserted in the correct positions.

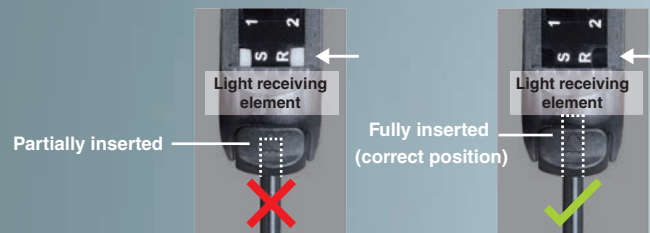

## Large LED indicators

Three-dimensional indicators provide operators with superb visibility of sensor status from a distance.





## Cover with wide opening angle

The cover opens up 180°, keeping it out of the way of the buttons. In addition, the display is clearly visible because the cover hides only the buttons.



## Larger buttons for secure operation

Larger buttons with the tilted top shape help operators easy setting of parameters.



## Easy-to-read OLED display

In addition to clear and detailed detection status and values displayed on the OLED display, the setting menu can be displayed in English, Japanese, Korean, Simplified Chinese or Spanish.



## Stretch display mode of received light amount

Displayed values of threshold and received light amounts can be set to be multiplied by 10 or 50 for easier perception.

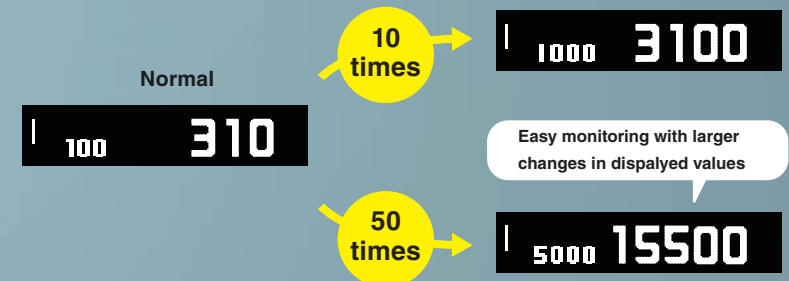

## Hold display

Amounts of received light can be set to display at peak/bottom values. This makes you easier to grasp exact values of detection to adjust a threshold with correct operation margin.

The received light amount fluctuates in real time, making it difficult to read the display.

The peak and bottom values can be held on the display.

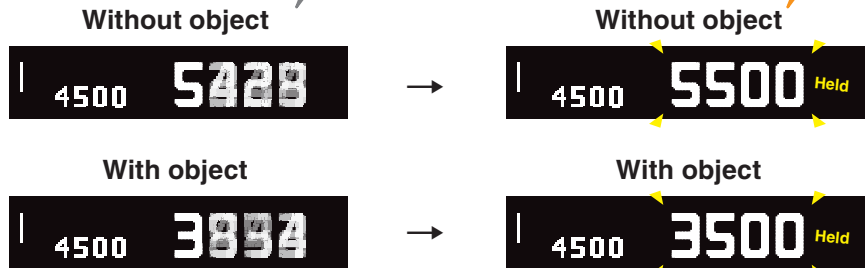

## Enhanced detection in a long distance

High-power LEDs combined with a lens designed for high efficiency increased the sensing distance. This ensures detection that is stable and resistant to dust and contamination.

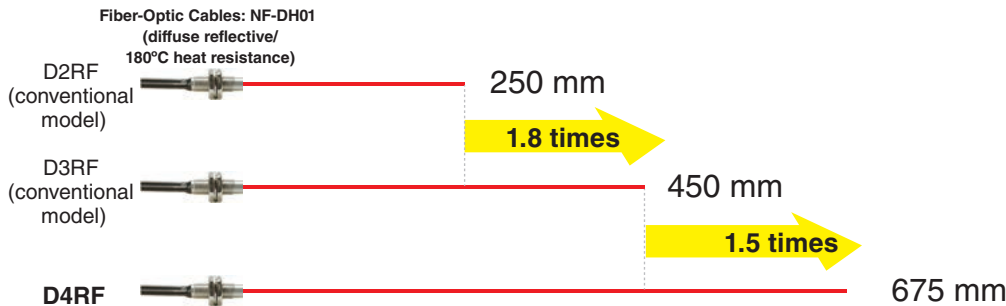

## Batch setting to connect Fiber-Optic Sensors

Batch setting to connected Fiber-Optic Sensors. Settings such as "Copy to all", "Zeroing all" and "All teach" are copied from the main unit to the expansion units as a batch. Max. 15 units of Fiber-Optic Sensors can be connected.

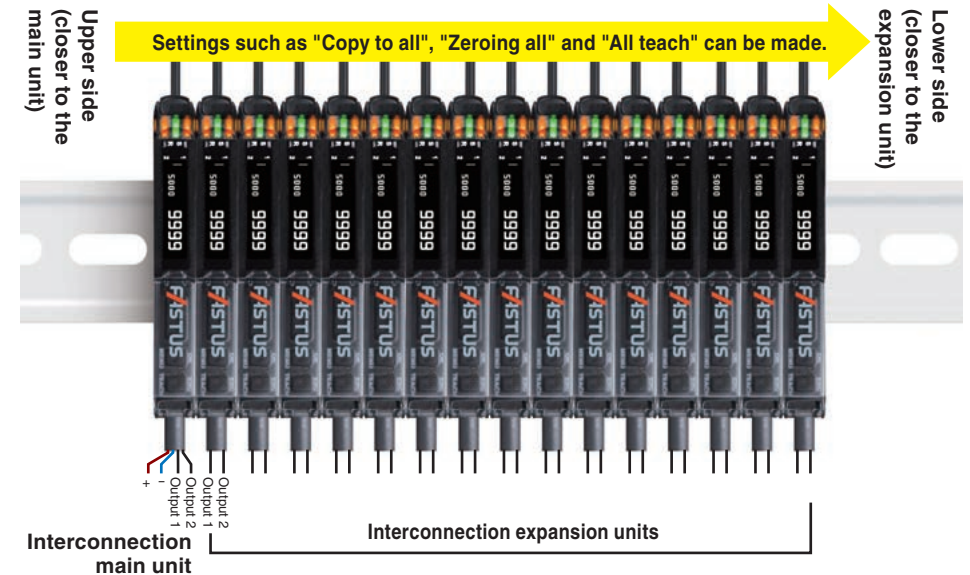





## Ultra-fast response time

Response time can be selected from 6 speed modes, as fast as 16  $\mu$ s. This facilitates 30,000 or more objects to be detected in 1 second.



## Lineup

### Stand-alone type

	Interface	OLED display and keys	Cable	Connector	Model
4-element Red LED	1-output + 1-switchable-output/input,  IO-Link	✓	✓		D4RF-T
		✓		✓	D4RF-TC4
	2-output + 1-input,  IO-Link	✓	✓		D4RF-TD
	Analog output + 1-output + 1-input	✓	✓		D4RF-TA
Short-range small object detection (4-element Red LED) <span style="color:red">NEW</span>	1-output + 1-switchable-output/input,  IO-Link	✓	✓		D4RF-T-Y
	2-output + 1-input,  IO-Link	✓	✓		D4RF-TD-Y
	Analog output + 1-output + 1-input	✓	✓		D4RF-TA-Y
Water (component) detection by short-wavelength infrared (Infrared LED, wavelength: 1450 nm) <span style="color:red">NEW</span>	1-output + 1-switchable-output/input,  IO-Link	✓	✓		D4IF-T
		✓		✓	D4IF-TC4

### Interconnection type (for communication unit)

	Interface	OLED display and keys	Cable	Connector	Cable-less	Type	Model
4-element Red LED	2-output + 1-input	✓	✓			Main unit	D4RF-TDM
	1-output + 1-switchable-output/input	✓	✓				D4RF-TM
	2-output + 1-input	✓	✓			Expansion unit	D4RF-TDS
	1-output + 1-switchable-output/input	✓	✓				D4RF-TS
	1-output + 1-switchable-output/input	✓		✓		Main unit	D4RF-TMC4
	1-output + 1-switchable-output/input	✓		✓		Expansion unit	D4RF-TSC4
For interconnection communication unit only (4-element Red LED) <span style="color:red">NEW</span>	-			✓		Main unit	D4RF-MC4
	-	✓			✓		D4RF-TM-0
	-	✓			✓	Expansion unit	D4RF-TS-0
	-				✓		D4RF-S
Short-range small object detection (4-element Red LED) <span style="color:red">NEW</span>	2-output + 1-input	✓	✓			Main unit	D4RF-TDM-Y
	2-output + 1-input	✓	✓			Expansion unit	D4RF-TDS-Y

## Options/Accessories



#### Connector cables

Straight  
M84CN-2S Cable length: 2 m  
M84CN-5S Cable length: 5 m  
M84CN-10S Cable length: 10 m



#### End plate

BEF-EB01-W190  
(2 pieces)

## Communication Unit



EtherCAT  
Communication Unit  
UC1-EC



EtherNet/IP  
Communication Unit  
UC1-EP



IO-Link Gateway  
UC2-IOL

EtherCAT

EtherNet/IP

IO-Link

# NEW Short-range/High accuracy type

D4RF-T-Y / D4RF-TD-Y / D4RF-TA-Y / D4RF-TDM-Y / D4RF-TDS-Y

- Detects small objects in a clean environment
- Detects minute changes in light intensity

Detection of small objects with only minute changes in light intensity



Passing detection of small objects

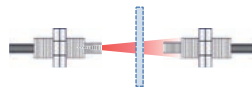

Transparent-object detection

Short-range detection of small objects



## Applications

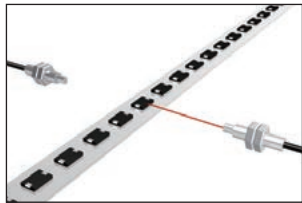

**Passing Detection of Electronics Components**

Even at close ranges, detection of small objects is possible without an excessive received light amount.

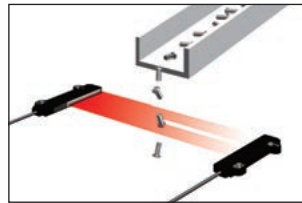

**Counting the Number of Dropped Screws/Small Objects**

Detection of even slight changes in the received light amount is possible when using a screen fiber.

## Lineup

Interface	OLED display and keys	Cable	Type	Model
1-output + 1-switchable-output/input,  IO-Link	✓	✓	Stand-alone	D4RF-T-Y
2-output + 1-input,  IO-Link	✓	✓		D4RF-TD-Y
Analog output + 1-output + 1-input	✓	✓		D4RF-TA-Y
2-output + 1-input	✓	✓	Interconnection	Main unit D4RF-TDM-Y
	✓	✓		Expansion unit D4RF-TDS-Y

# Analog output type

D4RF-TA / D4RF-TA-Y

Selectable according to your analog devices. \* Current output: 4 to 20 mA \* Voltage output: 0 to 10 V or 1 to 5 V

- Manual adjustment of the analog output range

The analog output range set with the teach function can be changed manually.

[Setting examples]

When the received light amount is within the analog output range (200 to 800), a current of 4 to 20 mA is output.



Display the setting analog output values (4 mA → 200, 20 mA → 800)

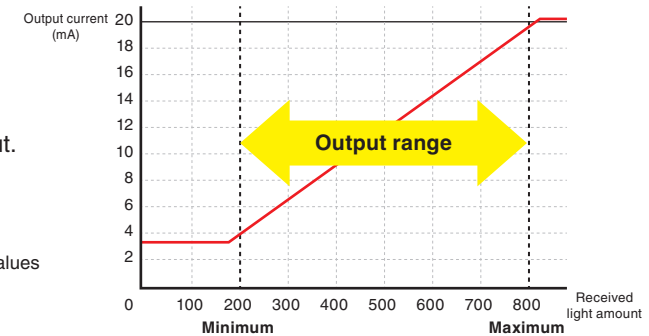

## Applications

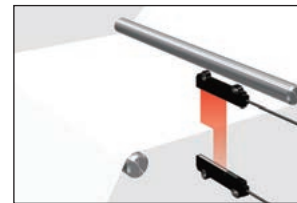

**Detection of Film Meandering**

Fiber-Optic Sensors with analog output can feedback the position of the edge by analog output.

Screen Fiber-Optic Cables NF-TS40 can be utilized for alignment control. It has 40 mm width screen beam and in that area the sensor can detect edge of the film.

## Lineup

Interface	OLED display and keys	Cable	Type	Model
Analog output + 1-output + 1-input	✓	✓	Stand-alone	D4RF-TA
	✓	✓		D4RF-TA-Y

# NEW Infrared light source type

D4IF-T / D4IF-TC4

- Adopts the 1,450 nm wavelength that is easily absorbed by water (component)
- Wide variety of infrared light source–related applications

## Applications



**Detection of Chemicals in Transparent Bottles**  
Infrared LED light at 1,450 nm, which is easily absorbed by water (component), allows detection of chemicals because the light is received when chemicals are not present and not received when chemicals block the optical axis.

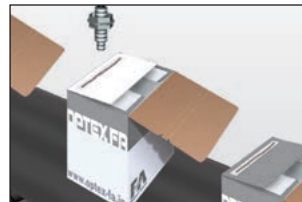

**Detection of Adhesives**  
Infrared light with a wavelength of 1,450 nm is easily absorbed by the water (component) in adhesive, so if adhesive is present, the light will be absorbed and the received light amount will decrease. If no adhesive is present, the light will be reflected by the substrate, increasing the received light amount.

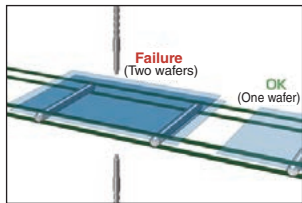

**Silicon Solar Panel Overlap Detection**  
The moderate penetration of 1,450 nm wavelength infrared light with silicon solar panels makes it possible to detect overlaps based on the difference in received light amount of one wafer compared with two wafers.

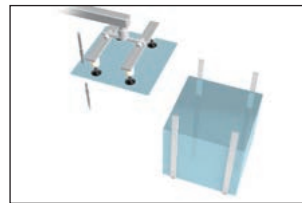

**Pick-and-press Laminated Film Overlap Detection**  
Because 1,450 nm infrared light is easily absorbed by films, the difference in the received light amount can be used to distinguish between one or two sheets even if the film is transparent.

## Lineup

Interface	OLED display and keys	Cable	Cable	Type	Model
1-output + 1-switchable-output/input, IO-Link	✓	✓		Stand-alone	D4IF-T
	✓		✓		D4IF-TC4

## Fiber-Optic Cables

Type	Dimensions (mm)	D4IF Sensing distance (mm)	Ambient temperature	Min bending radius (mm)	Model
Through-beam type M4		8 ms	-40 to +200°C	R25	NF-TW01
		795			
		2 ms			
		605			
		1 ms			
		470			
		500 μs			
		345			
		250 μs			
		315			
70 μs					
255					
16 μs					
95					
Diffuse reflective type M6		8 ms	-40 to +200°C	R25	NF-DW01
		210			
		2 ms			
		155			
		1 ms			
		115			
		500 μs			
		80			
		250 μs			
		75			
70 μs					
60					
16 μs					
23					

- The sensing distances for the diffuse reflective type Fiber-Optic Cables are values on 500 x 500 mm white paper.
- Install with an ambient humidity between 35 and 85%. In the case of 85% RH, the ambient temperature should be between 0 and +40°C.
- Plastic fibers cannot be used with 1,450 nm wavelength, which penetrates resin. Use a dedicated glass strand fiber unit. \*Combination units with heat-resistant fibers made of glass strands can also be used.

# Interconnection type for communication unit

D4RF-TM-0 / D4RF-TS-0 / D4RF-MC4 / D4RF-S

The lineup includes communication units with various interconnection types to meet diverse customer needs — for example, eliminating the display or operation keys by allowing settings and monitoring by PLC or IPC, or reducing cables.

- Max. 16 units of Fiber-Optic Sensors can be connected.
- Communication of output and identification.
- **Reduced wiring** : Simply connect to gateway. Cable-less types are also available. (When interconnecting four or more Fiber-Optic Sensors, supply power not only to the UC2-IOL but also to the Fiber-Optic Sensors main unit on the left end.)
- **Low cost and low current consumption** : Types without OLED displays are also available.



Cable-less type

D4RF-TM-0  
D4RF-TS-0



Connector type without OLED display and keys

D4RF-MC4



Cable-less type without OLED display and keys

D4RF-S

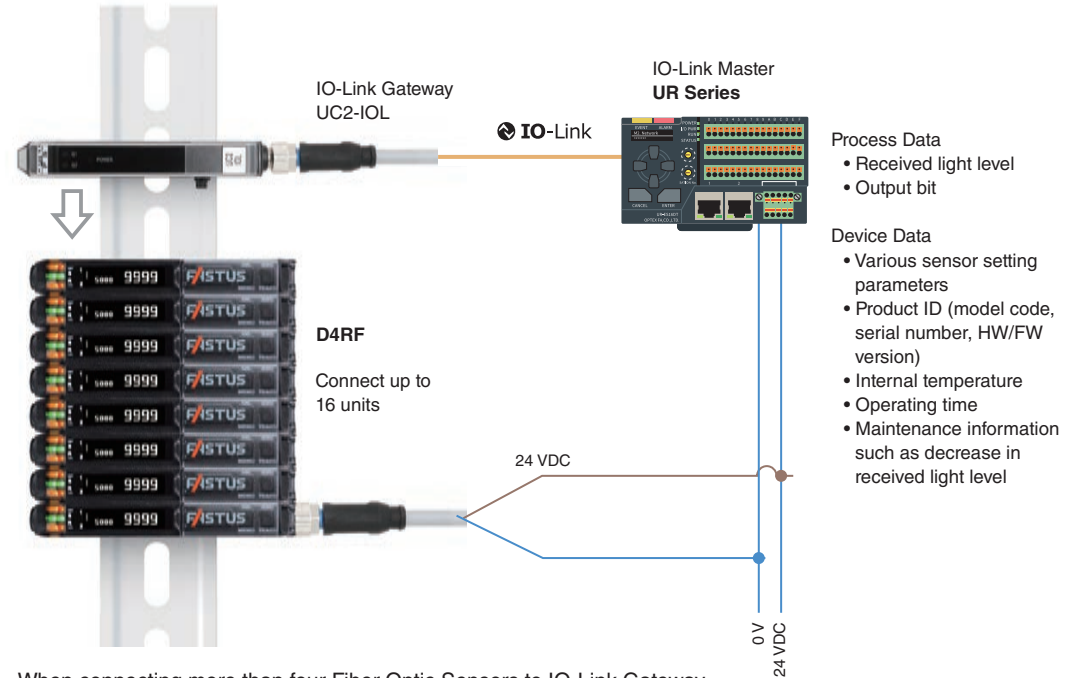

When connecting more than four Fiber-Optic Sensors to IO-Link Gateway UC2-IOL, additional 24 VDC power must be supplied to the terminal Fiber-Optic Sensor.

The 0 V of the supply power should be connected to the 0 V of the power supplied to IO-Link Master to match the potential.

If there are three or less Fiber-Optic Sensors, additional power is not required.

## ● Connectable communication unit

IO-Link Gateway UC2-IOL

IO-Link



By connecting D4RF to UC2-IOL, connected type that cannot communicate via IO-Link can be connected to IO-Link Master.  
\*Use UC2 with firmware version 2.1.0R or later (from lot 2307 or later).

EtherCAT Communication Unit UC1-EC

EtherCAT



By connecting D4RF to UC1-EC, it can communicate with PLC via EtherCAT.  
\*Use UC1 with firmware version 1.1.0 or later.

















EtherNet/IP Communication Unit UC1-EP

EtherNet/IP

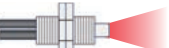

By connecting D4RF to UC1-EP, it can communicate with PLC via EtherNet/IP.  
\*Use UC1 with firmware version 1.2.0 or later.

## ■ Sensing distance (typical Fiber-Optic Cables models)

Reflection mode	Model	Type	Shape	Core				Sensing distance by response time (Unit: mm) Upper row: D4RF Lower row: D4RF-Y						
				Type	Minimum bending radius	Fiber length	Light axis diameter	16 μs	70 μs	250 μs	500 μs	1 ms	2 ms	8 ms
Through-beam type	NF-TB02	M4	 M2.6, Lens attachable	Standard	R25	2 m Free cut	ø1.0	325	975	1,455	1,960	2,215	2,780	3,600
								55	165	240	295	340	445	545
	NF-TK77	M4	 M2.6, Lens attachable	Flexible	R1	2 m Free cut	ø1.0	310	915	1,415	1,770	2,010	2,710	3,600
								55	165	240	295	340	445	545
	NF-TR01	M4	 M2.6, Lens attachable	Flexible	R4	2 m Free cut	ø1.0	320	955	1,505	1,835	2,055	2,880	3,600
								55	165	240	295	340	445	545
	NF-TR02	M3	 M2.6, Lens attachable	Flexible	R4	2 m Free cut	ø0.25 × 4	85	265	420	525	595	865	1,310
								14	40	60	70	85	110	140
	NF-TM02	M3	 Sleeve: 5 mm long	Standard	R15	2 m Free cut	ø0.5	100	290	465	600	680	965	1,540
								15	50	75	95	110	150	190
NF-TR14	M4	 Straight view/Side view switchable type	Flexible	R2	2 m Free cut	ø0.5	305	885	1,430	1,845	2,200	2,730	3,600	
							50	140	200	255	295	385	470	
NF-TS40	Screen	 40 mm	Flexible	R2	2 m Free cut	40 mm	3,600	3,600	3,600	3,600	3,600	3,600	3,600	
							55	165	240	295	340	445	545	
NF-TZ07	Screen	 32 mm	Flexible	R1	2 m Free cut	32 mm	3,600	3,600	3,600	3,600	3,600	3,600	3,600	
							55	165	240	295	340	445	545	
NF-TZ08	Screen	 32 mm	Standard	R10	2 m Free cut	32 mm	3,600	3,600	3,600	3,600	3,600	3,600	3,600	
							55	165	240	295	340	445	545	
NF-TZ09	Screen	 11 mm	Flexible	R1	2 m Free cut	11 mm	2,305	3,600	3,600	3,600	3,600	3,600	3,600	
							14	40	60	70	85	110	140	
NF-TZ10	Screen	 11 mm	Standard	R10	2 m Free cut	11 mm	2,765	3,600	3,600	3,600	3,600	3,600	3,600	
							15	50	75	95	110	150	190	
Diffuse reflective type	NF-DK06	M6		Standard	R25	2 m Free cut	Parallel	120	300	500	600	700	800	1,250
								14	45	65	75	90	130	160
	NF-DB01	M6		Standard	R25	2 m Free cut	Coaxial	120	300	500	600	700	800	1,250
								14	45	65	75	90	130	160
	NF-DM02	M4		Standard	R15	2 m Free cut	Coaxial	45	170	265	320	380	505	710
								7	20	30	35	40	60	75
	NF-DK21	M3		Standard	R15	0.5 m	Coaxial	15	60	95	115	135	180	260
								3	8	12	15	17	25	34
	NF-DK67	M6		Flexible	R2	2 m Free cut	Parallel	95	315	485	525	645	840	1,130
								13	40	60	70	80	120	150
NF-DR01	M6		Flexible	R4	2 m Free cut	Parallel	120	300	500	600	700	800	1,250	
							14	45	65	75	90	130	160	

● The sensing distances for diffuse reflective Fiber-Optic Cables are reference values measured using a 500 × 500 mm white paper.

# I/O circuit diagrams

## Stand-alone type (IO-Link device)

[1-output and 1-switchable-output/input type]  
(D4RF-T/D4RF-TC4/D4RF-T-Y/D4IF-T/D4IF-TC4)

### IO-Link mode

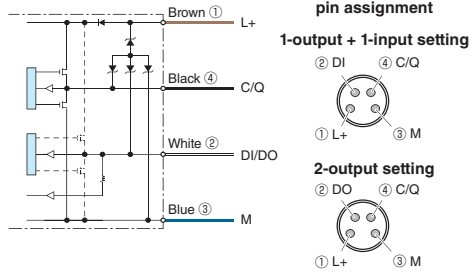

[2-output and 1-input type]  
(D4RF-TD/D4RF-TD-Y)

### IO-Link mode

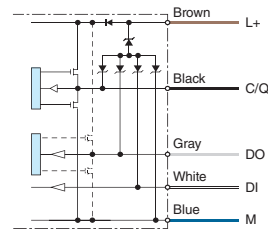

[1-output and 1-switchable-output/input type] (D4RF-T/D4RF-TC4/D4RF-T-Y/D4IF-T/D4IF-TC4)

SIO mode (standard I/O mode)  
NPN setting

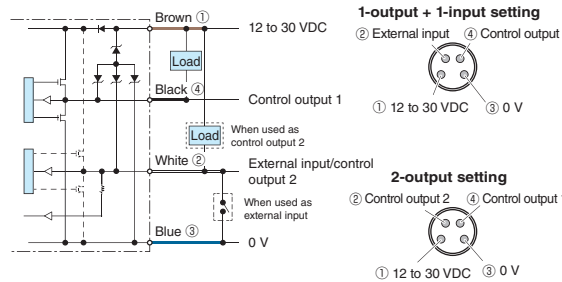

SIO mode (standard I/O mode)  
PNP or Push-pull setting

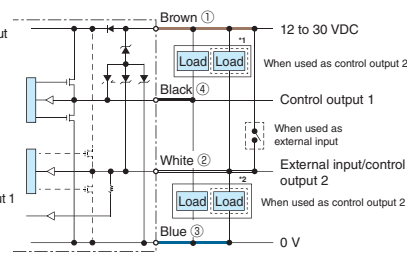

[2-output and 1-input type] (D4RF-TD/D4RF-TD-Y)

SIO mode (standard I/O mode)  
NPN setting

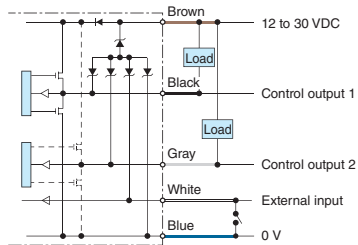

SIO mode (standard I/O mode)  
PNP or Push-pull setting

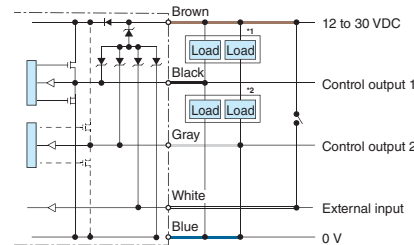

## Interconnection type

[1-output and 1-switchable-output/input type, including type without output/input wires]  
(D4RF-TM/D4RF-TS/D4RF-TMC4/D4RF-TSC4/D4RF-MC4)

### NPN setting

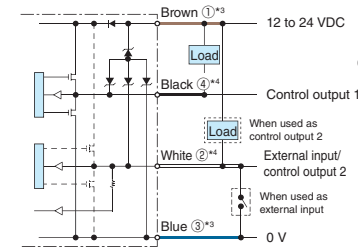

### M8 connector pin assignment

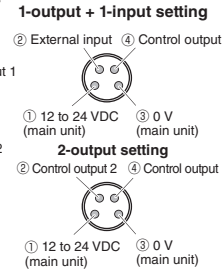

### PNP or Push-pull setting

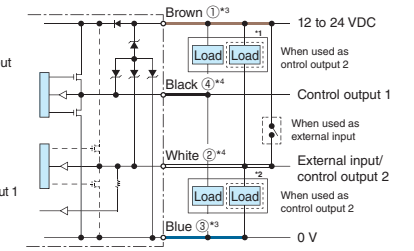

[2-output and 1-input type] (D4RF-TDM/D4RF-TDM-Y/D4RF-TDS/D4RF-TDS-Y)

### NPN setting

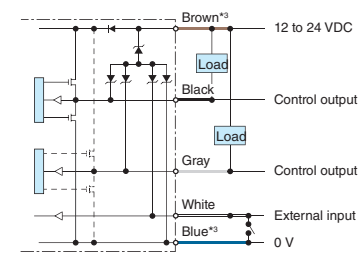

### PNP or Push-pull setting

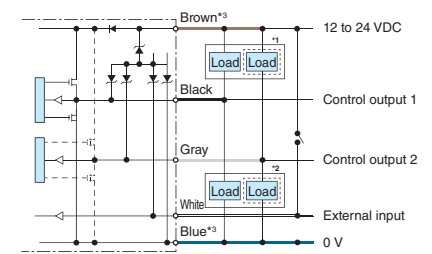

## Analog output type

(D4RF-TA/D4RF-TA-Y)

### NPN setting

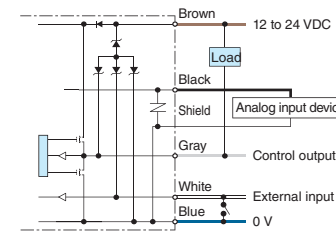

### PNP or Push-pull setting

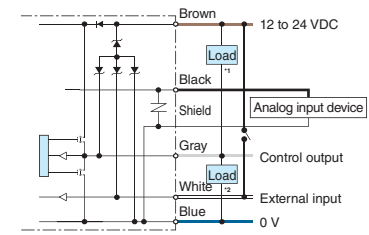

\*1 When I/O polarity is set to Push-pull and the sensor is connected with plus common circuits. \*2 When I/O polarity is set to Push-pull or PNP and the sensor is connected with minus common circuits. \*3 Power supply wires (Brown ①, Blue ③) are not equipped on the interconnection expansion units. \*4 Input and output wires (White ②, Black ④) are not equipped on type "Without output/input wires".

## Model specifications for stand-alone type

Type		Stand-alone (IO-Link device)		Stand-alone unit, infrared light source (IO-Link device)		Analog output		
<b>Model</b>	<b>1-output and 1-switchable-output/input<sup>*1</sup></b>	<b>Cable</b>	D4RF-T	D4IF-T	-			
		<b>Connector</b>	D4RF-TC4	D4IF-TC4	-			
	<b>1-output and 1-switchable-output/input, short-range/high accuracy<sup>*1</sup></b>	<b>Cable</b>	D4RF-T-Y	-	-			
		<b>Cable</b>	D4RF-TD	-	-			
	<b>2-output and 1-input</b>	<b>Cable</b>	D4RF-TD-Y	-	-			
	<b>2-output and 1-input, short-range/high accuracy</b>	<b>Cable</b>	D4RF-TD-Y	-	-			
<b>Analog output</b>	<b>Cable</b>	-	-	-	D4RF-TA			
<b>Analog output, short-range/high accuracy</b>	<b>Cable</b>	-	-	-	D4RF-TA-Y			
<b>Light source</b>		4-element Red LED (Wavelength: 660 nm)		Infrared LED (Wavelength: 1,450 nm) <sup>*2</sup>		4-element Red LED (Wavelength: 660 nm)		
<b>Response time</b>		16 μs, 70 μs, 250 μs, 500 μs, 1 ms, 2 ms, 8 ms						
<b>Teach Mode</b>		1 point, 2 points, Auto, Through, 1-point Zone, 2-point Zone, Manual				Channel A (Analog output) setting: Analog 2 points teach, Analog auto teach, Manual Channel 1 (Control output) setting: 1 point, 2 points, Auto, Through, 1-point Zone, 2-point Zone, Manual		
<b>Display</b>	<b>Digital display</b>	OLED display 128 x 22 pixel Menu languages: English, Japanese, Korean, Simplified Chinese, Spanish						
	<b>Indicators</b>	2 x Output indicator (orange) Power indicator (green): Lights up when power is on (Blinks during IO-Link communication)				Control output indicator (orange), Analog output indicator (orange) Power indicator (green): Lights up when power is on		
<b>Interface</b>	<b>Control output</b>	NPN/PNP, open collector or Push-pull selectable by setting 1-output: Max. 100 mA, 2-output: Max. 50 mA /30 VDC residual voltage 1.8 V or less				NPN/PNP, open collector or Push-pull selectable by setting Max. 50 mA/30 VDC residual voltage 1.8 V or less		
	<b>Analog output</b>	-				Current output: 4 to 20 mA, load impedance: 300 ohm or less Voltage output: 0 to 10 V, 1 to 5 V, output impedance: 100 ohm or less selectable by setting		
	<b>External input</b>	Teach, Counter-reset, Emitter off or Preset loading <sup>*3</sup>				Teach, Counter-reset, Emitter off, Hold out reset or Preset loading <sup>*3</sup>		
	<b>IO-Link</b>	Control output 1 is switchable to IO-Link				-		
<b>IO-Link</b>	<b>Revision</b>	1.1				-		
	<b>Baud rate</b>	COM 3 (230.4kbps)				-		
	<b>Number of process input data bytes</b>	4 bytes				-		
	<b>Minimum cycle time</b>	0.5 ms				-		
<b>Timer function</b>		On delay, Off delay, On/off delay, Pulse output, On delay pulse Adjustable 1 to 30,000 ms						
<b>Output mode</b>		Light ON/Dark ON, selectable by setting						
<b>Connection</b>		Cable type: 2 m, 5 wires with 2-output and 1-input type, 4 wires with 1-output and 1-switchable-output/input type, Minimum bending radius: 4 x Cable diameter Connector type: M8 4-pin connector		Cable type: 2 m, 4 wires with 1-output and 1-switchable-output/input type, Minimum bending radius: 4 x Cable diameter Connector type: M8 4-pin connector		Cable type: 2 m, Minimum bending radius: 4 x Cable diameter		
<b>Rating</b>	<b>Supply voltage</b>	<b>SIO mode</b>	12 to 30 VDC ±10% including 10% ripple (p-p)				12 to 24 VDC ± 10% including 10% ripple (p-p)	
		<b>IO-Link mode</b>	18 to 30 VDC ±10% including 10% ripple (p-p)				-	
	<b>Current consumption</b>	<b>Eco mode: Off</b>	Max. 870 mW (29 mA or less at 30 VDC, 33 mA or less at 24 VDC, 52 mA or less at 12 VDC)				Max. 840 mW (35 mA or less at 24 VDC, 52 mA or less at 12 VDC)	
		<b>Eco mode: On</b>	Max. 780 mW (26 mA or less at 30 VDC, 29 mA or less at 24 VDC, 43 mA or less at 12 VDC)				Max. 744 mW (31 mA or less at 24 VDC, 43 mA or less at 12 VDC)	
<b>NRTL certification</b>		UL Listed or Recognized Components Proximity Switch Certified for US and Canada.				UL Recognized Component Proximity Switch Certified for US and Canada		
<b>Weight</b>		Cable type: approx. 71 g, Connector type: approx. 25 g				Approx. 71 g		

\*1: Analog output cannot be switched between input and output.

\*2: The 1,450 nm wavelength band has a large attenuation of water components.

\*3: Preset loading selectable only on 2-output and 1-output type.

## Model specifications for interconnection type

Type			Standard interconnection		Interconnection for communication unit				
			With display and keys		With display and keys		Without display and keys		
			Main unit	Expansion unit	Main unit	Expansion unit	Main unit	Expansion unit	
Model	1-output and 1-switchable-output/input	Cable	D4RF-TM	D4RF-TS	-	-	-	-	
	2-output and 1-input	Connector	D4RF-TMC4	D4RF-TSC4	-	-	-	-	
		Cable	D4RF-TDM	D4RF-TDS	-	-	-	-	
	2-output and 1-input, short-range/high accuracy	Cable	D4RF-TDM-Y	D4RF-TDS-Y	-	-	-	-	
	Without output/input wires	Connector	-	-	-	-	D4RF-MC4	-	
Cable-less type			-	-	D4RF-TM-0	D4RF-TS-0	-	D4RF-S	
Light source			4-element Red LED (Wavelength: 660 nm)						
Response time	Stand-alone use		16 μs, 70 μs, 250 μs, 500 μs, 1 ms, 2 ms, 8 ms	-	-	-	-	-	
	Interconnection use		22 μs, 70 μs, 250 μs, 500 μs, 1 ms, 2 ms, 8 ms						
Teach Mode			1 point, 2 points, Auto, Through, 1-point Zone, 2-point Zone, Manual						
Display			Digital display: OLED display 128 × 22 pixel. Menu languages: English, Japanese, Korean, Simplified Chinese, Spanish						
Indicators			2 × Output indicator (orange), Power indicator (green): Lights up when power is on						
Interface	Control output*1		NPN/PNP open collector or Push-pull selectable by setting 1-output: Max. 100 mA, 2-output: Max. 50 mA/ 30 VDC, residual voltage: 1.8 V or less			-			
	External input		Teach, Counter-reset, Emitter off or Preset loading*2			-			
Number of units with cross talk prevention			Response time 22 μs: 2 units, 70 μs: 3 units, 250 μs: 4 units, 500 μs: 9 units, 1 ms: 9 units, 2 ms: 12 units, 8 ms: 14 units (including main unit)						
Timer function			On delay, Off delay, On/off delay, Pulse output, On delay pulse, Adjustable 1 to 30,000 ms						
Output mode			Light ON/Dark ON, selectable by setting						
Number of connectable units			Max. 16 units (including main unit)						
Connection			Cable type: 2 m, Minimum bending radius: 4 × Cable diameter 5 wires with 2-output and 1-input main unit, 4 wires with 1-output and 1-switchable-output/input main unit, 3 wires with 2-output and 1-input expansion unit, 2 wires with 1-output and 1-switchable-output/input expansion unit, Connector type: M8 4-pin connector		Without cable or connector		Connector type: M8 4-pin connector (For supplying power)	Without cable or connector	
Rating	Supply voltage		Supplied directly or from communication unit*3 12 to 24 VDC ± 10% including 10% ripple (p-p)	Supplied from main unit or communication unit*3 12 to 24 VDC ± 10% including 10% ripple (p-p)	Supplied from communication unit*3 12 to 24 VDC ± 10% including 10% ripple (p-p)		Supplied directly or from communication unit*3 12 to 24 VDC ± 10% including 10% ripple (p-p)	Supplied from communication unit*3 12 to 24 VDC ± 10% including 10% ripple (p-p)	
	Current consumption*1	Eco mode: Off	Max. 792 mW (33 mA or less at 24 VDC, 52 mA or less at 12 VDC)		Max. 720 mW (30 mA or less at 24 VDC, 49 mA or less at 12 VDC)		Max. 624 mW (26 mA or less at 24 VDC, 41 mA or less at 12 VDC)		
		Eco mode: On	Max. 696 mW (29 mA or less at 24 VDC, 43 mA or less at 12 VDC)		Max. 624 mW (26 mA or less at 24 VDC, 41 mA or less at 12 VDC)		-		
NRTL certification			UL Listed or Recognized Components Proximity Switch Certified for US and Canada.						
Weight			Cable type: approx. 71 g, Connector type: approx. 25 g		Approx. 23 g				

\*1: The load current and ambient temperature are limited by the number of connected units (including interconnection main unit) as shown in the table below.

Standard interconnection use: 20 mA when connected with a 1-output setting or 10 mA with a 2-output setting.

\*2: Preset loading selectable only on 2-output and 1-output type.

\*3: For details on supplying power from the communication unit, refer to the instruction manual of the respective communication unit.

\*4: The upper ambient temperature limit is as follows depending on the number of connected units.

3 to 5 connected units: 50°C, 6 to 16 connected units: 45°C (When used as UL certified product, 6 to 8 connected units: 45°C, 9 to 16 connected units: 40°C)

● Specifications are subject to change without prior notice.

## Common specifications

Insulation resistance		20 megaohms or more (with 500 VDC)
Warm-up time		300 ms
Applicable regulations	EMC	EU EMC directive (2014/30/EU) UK directive EMC (The Electromagnetic Compatibility Regulations 2016)
	Environment	EU RoHS directive (2011/65/EU) UK RoHS (The Restriction of the Use of Certain Hazardous Substances in Electrical and Electronic Equipment Regulations 2012) China RoHS (MIIT Order No.32)
Applicable standards		EN 60947-5-2
Company standards		Noise resistance: Feilen Level 4 cleared
Protection circuit		Reverse connection protection, Overcurrent protection
Environmental resistance	Ambient temperature <sup>4</sup> /humidity	-25 to 55°C/35 to 85% RH (no freezing or condensation)
	Ambient illuminance	Sunlight: 10,000 lx or less, Incandescent light: 3,000 lx or less
	Vibration resistance	10 to 55 Hz, Double amplitude 1.5 mm; 2 hours in each of the X, Y, and Z directions
	Shock resistance	Approx. 50 G (500 m/s <sup>2</sup> ) 3 times in each of the X, Y, and Z directions
	Degree of protection	IP54
Material		Housing, Cover: PC
Included accessories		Mounting bracket, Instruction manual



OPTEx FA CO., LTD.

91 Chudoji-Awata-cho, Shimogyo-ku, Kyoto 600-8815 JAPAN

www.optex-fa.com